

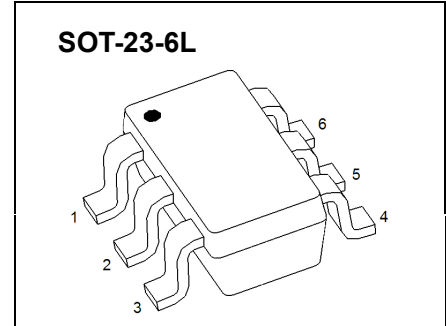

**SOT-23-6L Plastic-Encapsulate MOSFETS**

**CJL1206** Dual P-Channel Power MOSFET

$V_{(BR)DSS}$	$R_{DS(on)MAX}$	$I_D$
-12V	45 mΩ@-4.5V	-6A
	60 mΩ@-2.5V	
	90 mΩ@-1.8V	



**FEATURE**

- TrenchFET Power MOSFET

**APPLICATION**

- Load Switch for Portable Devices
- DC/DC Converter

**MARKING**

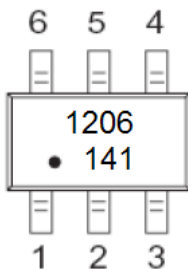

**Equivalent Circuit**

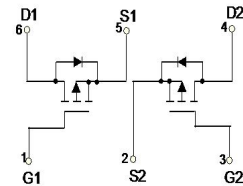

**Maximum ratings ( $T_a=25^{\circ}C$  unless otherwise noted)**

Parameter .....	Symbol	Value	Unit
Drain-Source Voltage	$V_{DS}$	-12	V
Gate-Source Voltage	$V_{GS}$	$\pm 8$	
Continuous Drain Current	$I_D$	-6	A
Continuous Source-Drain Diode Current	$I_S$	-0.8	
Maximum Power Dissipation	$P_D$	0.35	W
Thermal Resistance from Junction to Ambient( $t \leq 10s$ )	$R_{\theta JA}$	357	$^{\circ}C/W$
Junction Temperature	$T_J$	150	$^{\circ}C$
Storage Temperature	$T_{STG}$	-50 ~+150	

## MOSFET ELECTRICAL CHARACTERISTICS

$T_a = 25^\circ\text{C}$  unless otherwise specified

Parameter	Symbol	Test Condition	Min	Typ	Max	Units
<b>Static</b>						
Drain-source breakdown voltage	$V_{(BR)DSS}$	$V_{GS} = 0V, I_D = -250\mu A$	-12			V
Gate-source threshold voltage	$V_{GS(th)}$	$V_{DS} = V_{GS}, I_D = -250\mu A$	-0.5		-0.9	
Gate-source leakage	$I_{GSS}$	$V_{DS} = 0V, V_{GS} = \pm 8V$			$\pm 100$	nA
Zero gate voltage drain current	$I_{DSS}$	$V_{DS} = -8V, V_{GS} = 0V$			-1	$\mu A$
Drain-source on-state resistance <sup>a</sup>	$R_{DS(on)}$	$V_{GS} = -4.5V, I_D = -3.5A$		30	45	m $\Omega$
		$V_{GS} = -2.5V, I_D = -3A$		40	60	
		$V_{GS} = -1.8V, I_D = -2.0A$		60	90	
Forward transconductance <sup>a</sup>	$g_{fs}$	$V_{DS} = -5V, I_D = -4.1A$	6			S
<b>Dynamic</b>						
Input capacitance <sup>b,c</sup>	$C_{iss}$	$V_{DS} = -4V, V_{GS} = 0V, f = 1MHz$		740		pF
Output capacitance <sup>b,c</sup>	$C_{oss}$			290		
Reverse transfer capacitance <sup>b,c</sup>	$C_{rss}$			190		
Total gate charge <sup>b</sup>	$Q_g$	$V_{DS} = -4V, V_{GS} = -4.5V, I_D = -4.1A$		7.8	15	nC
		$V_{DS} = -4V, V_{GS} = -2.5V, I_D = -4.1A$		4.5	9	
Gate-source charge <sup>b</sup>	$Q_{gs}$	$V_{DS} = -4V, V_{GS} = -2.5V, I_D = -4.1A$		1.2		
Gate-drain charge <sup>b</sup>	$Q_{gd}$			1.6		
Gate resistance <sup>b,c</sup>	$R_g$	$f = 1MHz$	1.4	7	14	$\Omega$
Turn-on delay time <sup>b,c</sup>	$t_{d(on)}$	$V_{DD} = -4V, R_L = 1.2\Omega, I_D \approx -3.3A, V_{GEN} = -4.5V, R_g = 1\Omega$		13	20	ns
Rise time <sup>b,c</sup>	$t_r$			35	53	
Turn-off Delay time <sup>b,c</sup>	$t_{d(off)}$			32	48	
Fall time <sup>b,c</sup>	$t_f$			10	20	
Turn-on delay time <sup>b,c</sup>	$t_{d(on)}$	$V_{DD} = -4V, R_L = 1.2\Omega, I_D \approx -3.3A, V_{GEN} = -8V, R_g = 1\Omega$		5	10	
Rise time <sup>b,c</sup>	$t_r$			11	17	
Turn-off delay time <sup>b,c</sup>	$t_{d(off)}$			22	33	
Fall time <sup>b,c</sup>	$t_f$			16	24	
<b>Drain-source body diode characteristics</b>						
Continuous source-drain diode current	$I_S$	$T_C = 25^\circ\text{C}$			-1.4	A
Pulse diode forward current <sup>a</sup>	$I_{SM}$				-10	
Body diode voltage	$V_{SD}$	$I_F = -3.3A$			-1.2	V

**Note :**

- a. Pulse Test ; Pulse Width  $\leq 300\mu s$ , Duty Cycle  $\leq 2\%$ .
- b. Guaranteed by design, not subject to production testing.
- c. These parameters have no way to verify.

# Typical Characteristics

Output Characteristics

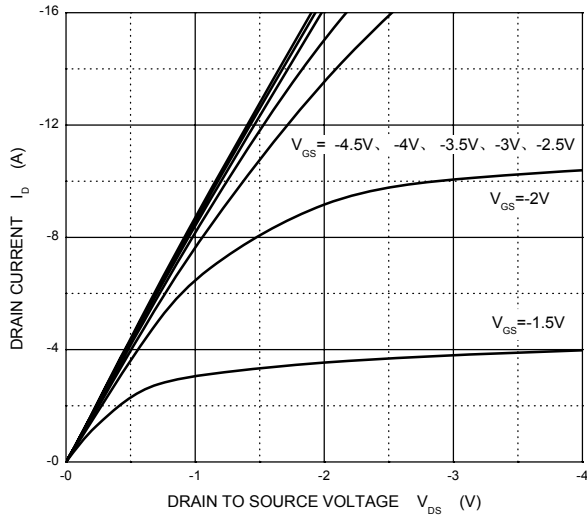

Transfer Characteristics

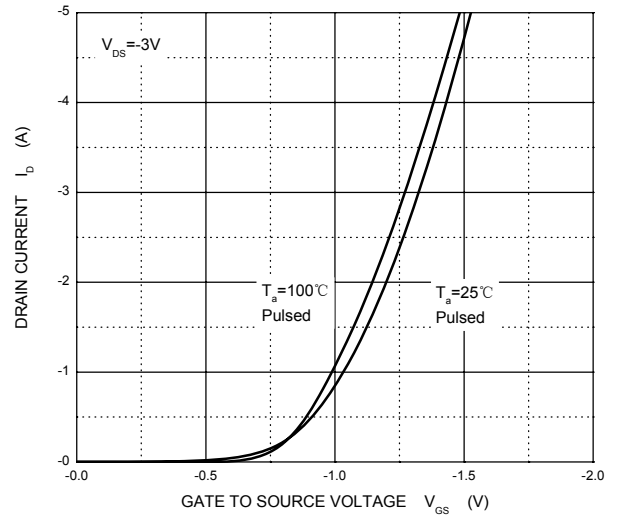

$R_{DS(ON)}$  —  $I_D$

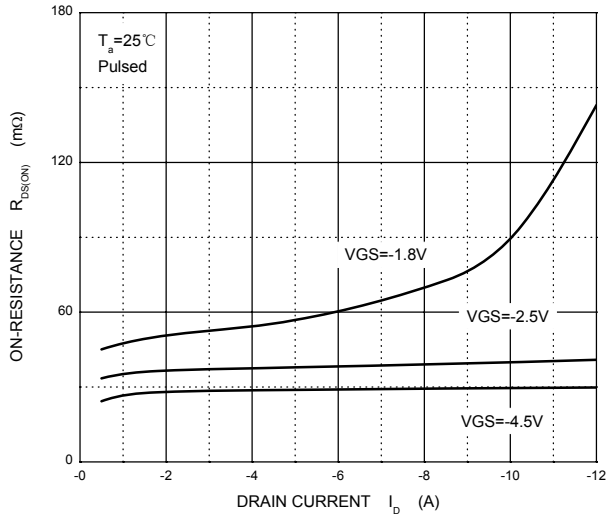

$R_{DS(ON)}$  —  $V_{GS}$

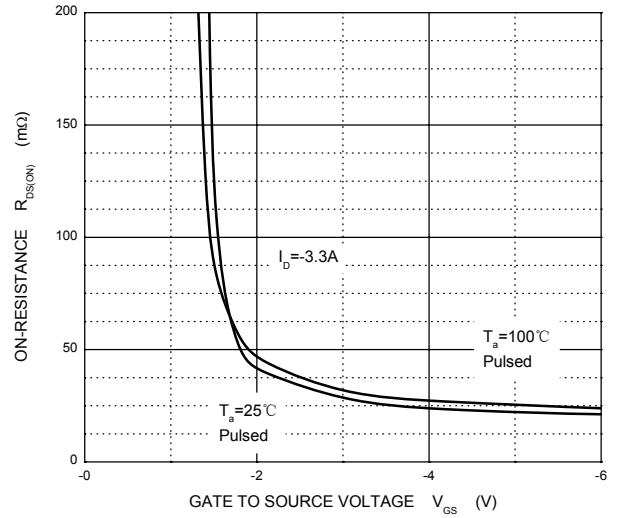

$I_S$  —  $V_{SD}$

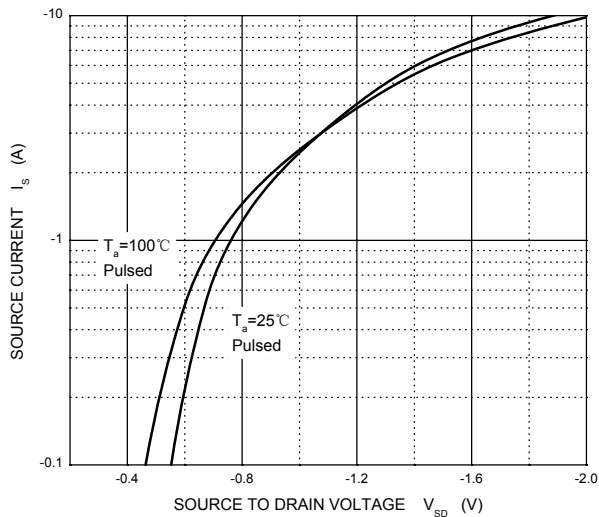

Threshold Voltage

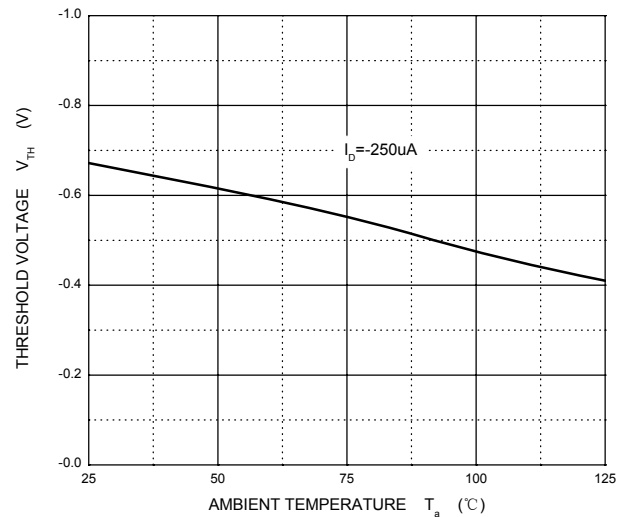

## SOT-23-6L Package Outline Dimensions

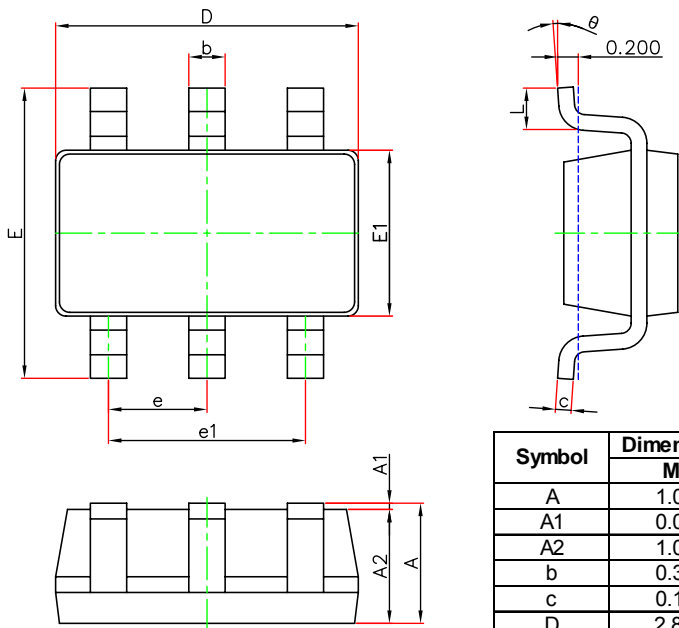

Symbol	Dimensions In Millimeters		Dimensions In Inches	
	Min.	Max.	Min.	Max.
A	1.050	1.250	0.041	0.049
A1	0.000	0.100	0.000	0.004
A2	1.050	1.150	0.041	0.045
b	0.300	0.500	0.012	0.020
c	0.100	0.200	0.004	0.008
D	2.820	3.020	0.111	0.119
E1	1.500	1.700	0.059	0.067
E	2.650	2.950	0.104	0.116
e	0.950(BSC)		0.037(BSC)	
e1	1.800	2.000	0.071	0.079
L	0.300	0.600	0.012	0.024
θ	0°	8°	0°	8°

## SOT-23-6L Suggested Pad Layout

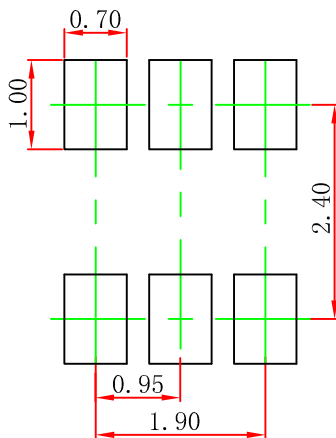

- Note:
1. Controlling dimension: in millimeters.
  2. General tolerance:  $\pm 0.05$  mm.
  3. The pad layout is for reference purposes only.

### NOTICE

JCET reserve the right to make modifications, enhancements, improvements, corrections or other changes without further notice to any product herein. JCET does not assume any liability arising out of the application or use of any product described herein.

# SOT-23-6L Tape and Reel

## SOT-23-6L Embossed Carrier Tape

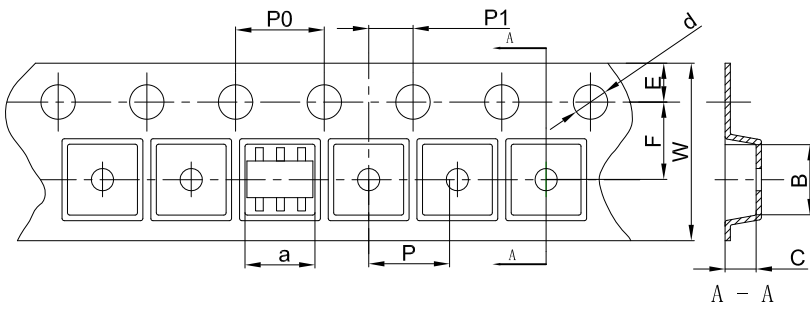

### Packaging Description:

SOT-23-6L parts are shipped in tape. The carrier tape is made from a dissipative (carbon filled) polycarbonate resin. The cover tape is a multilayer film (Heat Activated Adhesive in nature) primarily composed of polyester film, adhesive layer, sealant, and anti-static sprayed agent. These reeled parts in standard option are shipped with 3,000 units per 7" or 18.0cm diameter reel. The reels are clear in color and is made of polystyrene plastic (anti-static coated).

Dimensions are in millimeter										
Pkg type	a	B	C	d	E	F	P0	P	P1	W
SOT-23-6L	3.17	3.23	1.37	Ø1.55	1.75	3.50	4.00	4.00	2.00	8.00

## SOT-23-6L Tape Leader and Trailer

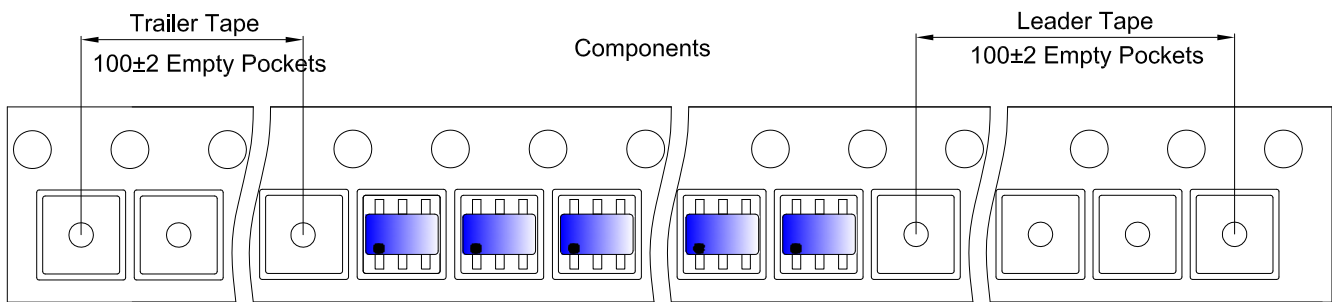

## SOT-23-6L Reel

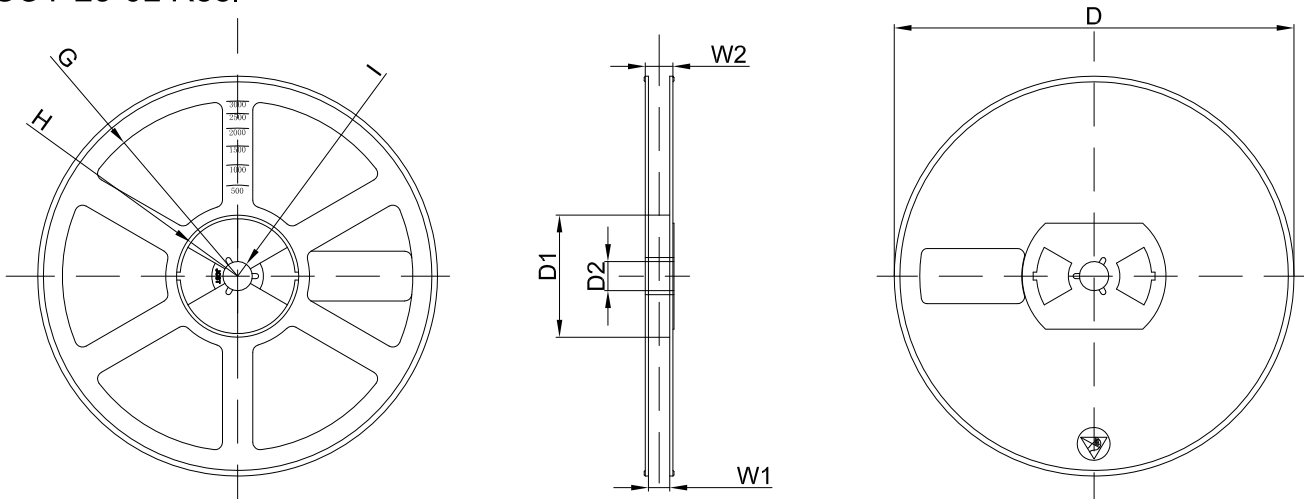

Dimensions are in millimeter								
Reel Option	D	D1	D2	G	H	I	W1	W2
7" Dia	Ø180.00	60.00	13.00	R78.00	R25.60	R6.50	9.50	13.10

REEL	Reel Size	Box	Box Size(mm)	Carton	Carton Size(mm)	G.W.(kg)
3000 pcs	7 inch	30,000 pcs	203×203×195	120,000 pcs	438×438×220	