



TO-126 Plastic-Encapsulate Transistors

3DD13002 TRANSISTOR (NPN)

FEATURES

Power dissipation

$$P_{CM} : 1.25 \text{ W (} T_{amb}=25 \text{)}$$

Collector current

$$I_{CM} : 1 \text{ A}$$

Collector-base voltage

$$V_{(BR)CBO} : 600 \text{ V}$$

Operating and storage junction temperature range

$$T_J, T_{stg}: -55 \text{ to } +150$$

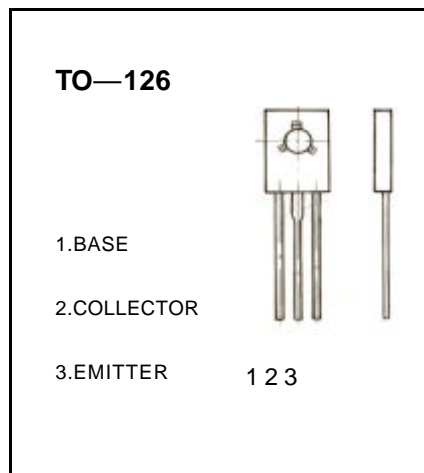

ELECTRICAL CHARACTERISTICS ($T_{amb}=25$ unless otherwise specified)

Parameter	Symbol	Test conditions	MIN	TYP	MAX	UNIT
Collector-base breakdown voltage	$V_{(BR)CBO}$	$I_C=100 \mu A, I_E=0$	600			V
Collector-emitter breakdown voltage	$V_{(BR)CEO}$	$I_C=1 \text{ mA}, I_B=0$	400			V
Emitter-base breakdown voltage	$V_{(BR)EBO}$	$I_E=100 \mu A, I_C=0$	6			V
Collector cut-off current	I_{CBO}	$V_{CB}=600 \text{ V}, I_E=0$			100	μA
Emitter cut-off current	I_{EBO}	$V_{EB}=6 \text{ V}, I_C=0$			100	μA
DC current gain	$h_{FE(1)}$	$V_{CE}=10 \text{ V}, I_C=250 \mu A$	5			
	$h_{FE(2)}$	$V_{CE}=10 \text{ V}, I_C=200 \text{ mA}$	9		40	
Collector-emitter saturation voltage	$V_{CE(sat)}$	$I_C=200 \text{ mA}, I_B=40 \text{ mA}$			0.8	V
Base-emitter saturation voltage	$V_{BE(sat)}$	$I_C=200 \text{ mA}, I_B=40 \text{ mA}$			1.1	V
Transition frequency	f_T	$V_{CE}=10 \text{ V}, I_C=100 \text{ mA}$ $f=1 \text{ MHz}$	5			MHz
Fall time	t_f	$I_C=1 \text{ A}, I_{B1}=-I_{B2}=0.2 \text{ A}$			0.5	μs
Storage time	t_s	$V_{CC}=100 \text{ V}$			2.5	μs

CLASSIFICATION OF $h_{FE(2)}$

Rank						
Range	9-15	15-20	20-25	25-30	30-35	35-40

Typical Characteristics

3DD13002

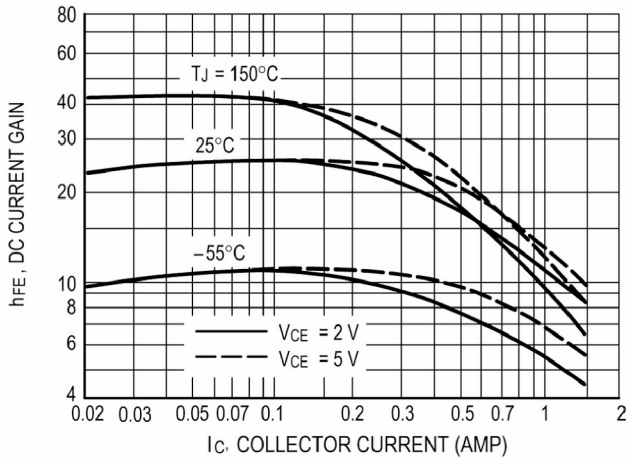

DC Current Gain

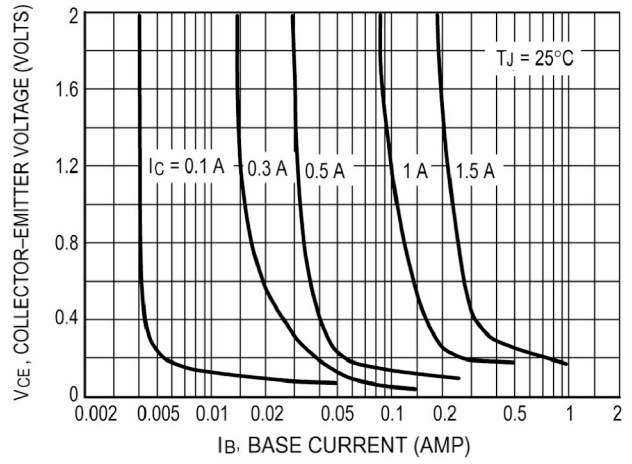

Collector Saturation Region

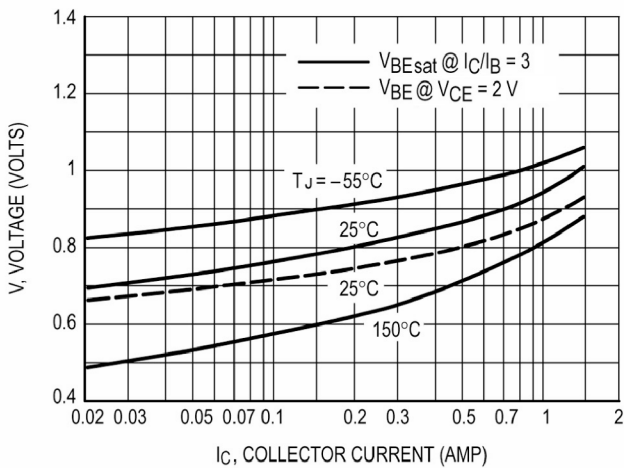

Base-Emitter Voltage

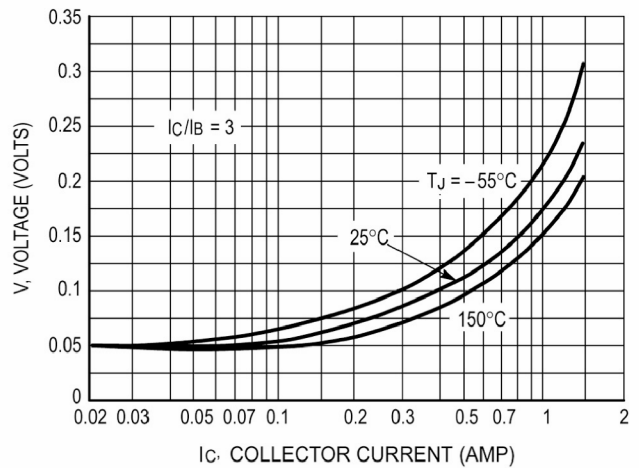

Collector-Emitter Saturation Region

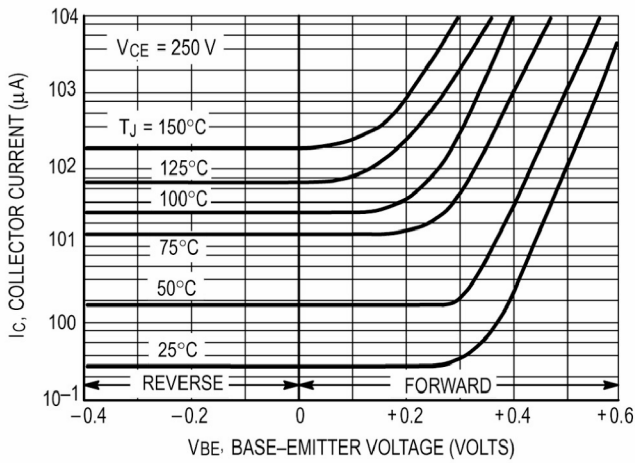

Collector Cutoff Region

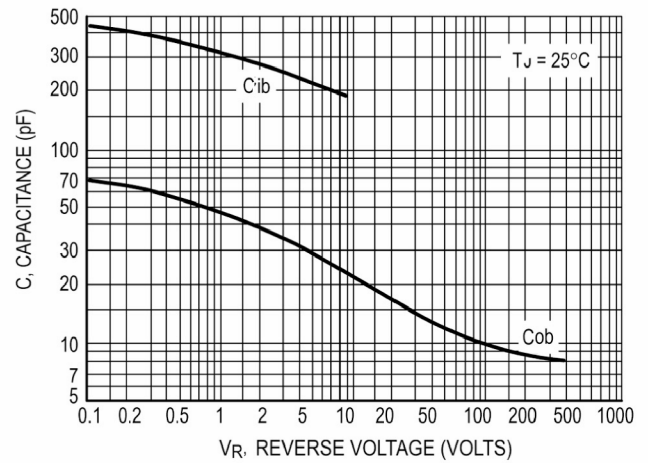

Capacitance

TO-126 PACKAGE OUTLINE DIMENSIONS

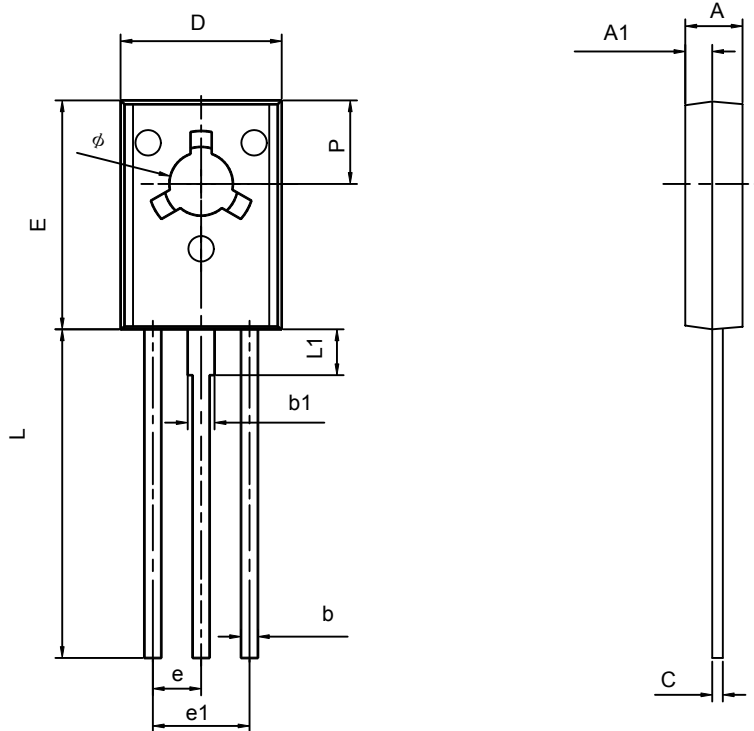

Symbol	Dimensions In Millimeters		Dimensions In Inches	
	Min	Max	Min	Max
A	2.500	2.900	0.098	0.114
A1	1.100	1.500	0.043	0.059
b	0.660	0.860	0.026	0.034
b1	1.170	1.370	0.046	0.054
c	0.450	0.600	0.018	0.024
D	7.400	7.800	0.291	0.307
E	10.600	11.000	0.417	0.433
e	2.290TYP		0.090TYP	
e1	4.480	4.680	0.176	0.184
L	15.300	15.700	0.602	0.618
L1	2.100	2.300	0.083	0.091
P	3.900	4.100	0.154	0.161
ϕ	3.000	3.200	0.118	0.126